

HELI X 158X[®]



OPERATION MANUAL V2.0

PARALLEL AUDIO

Please read and follow the instructions in this manual thoroughly to obtain optimum results from this unit. We also recommend that you keep this manual handy for future reference.

Safety Precautions

- Be sure to read the instructions in this section carefully before use.
- Make sure to observe the instructions in this manual as the conventions of safety symbols and messages regarded as very important precautions are included.

Safety symbols and messages described below are used in this manual to prevent bodily injury and property damage which could result from mishandling. Before operating your product, read this manual first and understand the safety symbols and messages so you are thoroughly aware of the potential safety hazards.

WARNING

Indicates a potentially hazardous situation which, if mishandled, could result in death or serious injury.

CAUTION

Indicates a potentially hazardous situation which, if mishandled, could result in moderate or minor personal injury, and/or property damage.

Make sure to observe the following handling precautions so that a fire or personal injury does not result from leakage or explosion of the battery.

- Do not short, disassemble, heat or put the battery into a fire.
- Never charge batteries of the type which are not rechargeable.
- Do not solder a battery directly.
- Be sure to use the specified type of battery.
- Note the correct polarity when inserting a battery in the unit.
- Avoid locations exposed to the direct sunlight, high temperature and high humidity when storing batteries.

WARNING

To prevent the electromagnetic wave from badly influencing medical equipment, make sure to switch off the units power when placing it in close proximity to the medical equipment.

CAUTION

Battery discharges naturally according to a certain pattern even when not in use. For best performance and a prolonged lifespan, battery should be charged regularly after every use or every month when the system is in storage and not being used. CD player optical pickup head is a very delicate device and sensitive to humidity. Please avoid using it in high humidity areas to avoid damage.

Congratulations and thank you for purchasing this multi-functional wireless portable amplifier. To ensure a trouble-free operation, please read the manual thoroughly to fully understand its controls and functions.

The rear panel of this portable amplifier is divided into 3 sections:

1. Module compartment
2. Control Unit compartment
3. Battery compartment

The Module Compartment is user configurable and user can access the battery compartment to replace battery.

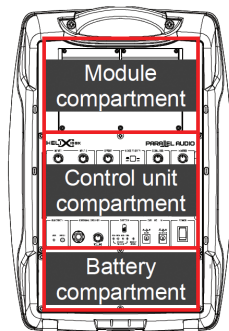

In the Box

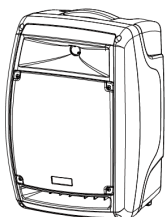

Helix 158X amplifier



0~4 transmitters
(handheld/beltpack)

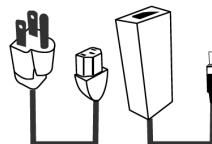

Switching power supply
(plug varies from country to country)



Operation manual

Note: The above specifications are subject to change without prior notice.

Optional Accessories

| MODULES & TRANSMITTERS | |
|------------------------|--------------------------------|
| RX8TD | True Diversity Receiver Module |
| RX8D | Diversity Receiver Module |
| RP5 | Repeater Module |
| DPR5 | MP3 Recorder Module |
| HH6100 | Handheld Transmitter |
| BP6100 | Beltpack Transmitter |

| SPEAKER | |
|-------------|---------------------------|
| HX-158x SP | Passive Extension Speaker |
| HX-8 PSR | Powered Extension Speaker |
| ACCESSORIES | |
| HX-8 ST | Standard Tripod Stand |
| HX-8 DC | Weatherproof Dust Cover |
| DM7SX | Wired Microphone |

Parts and Functions

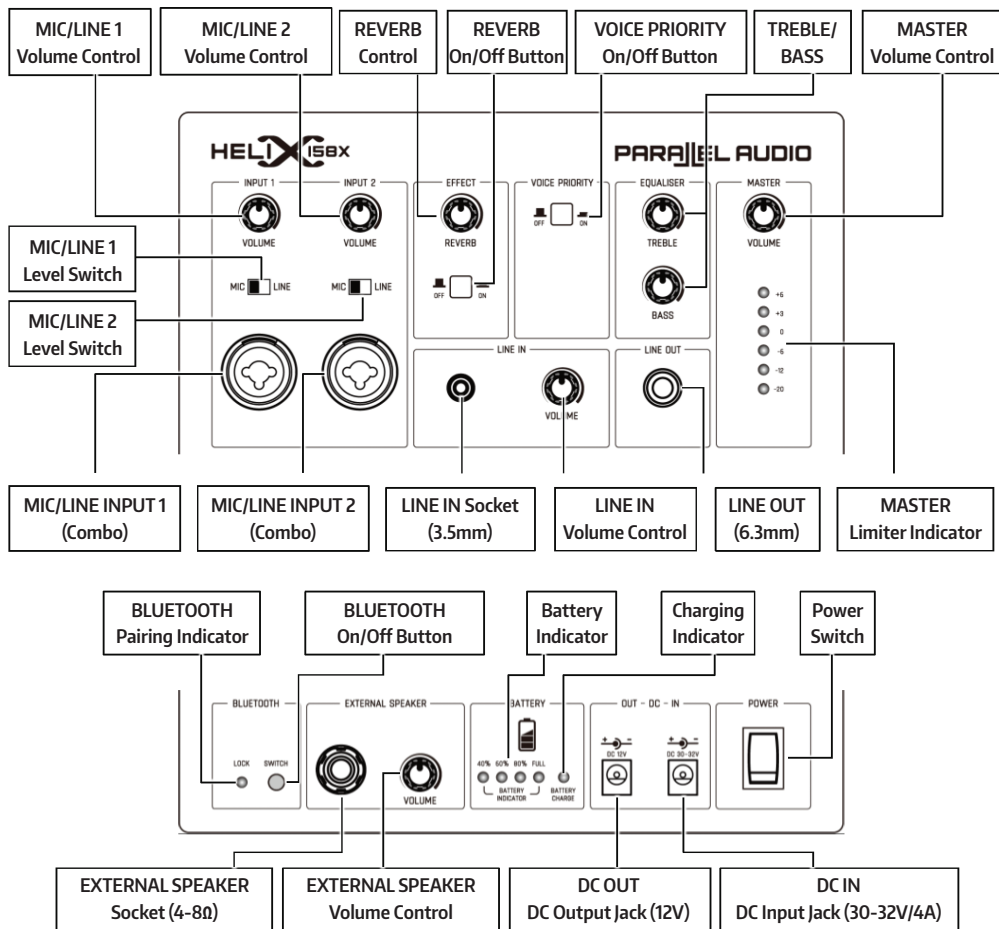

Charging the Battery

This amplifier uses either two lead-acid batteries or one lithium battery. The battery power is levelled from 40%, 60%, 80% and FULL. If the LED stays at 40%, the battery might not be sustainable for long operation.

| CHARGING INDICATOR | |
|------------------------|-----------------------------|
| LED Flashing RED | Currently Recharging |
| LED Illuminated GREEN | Fully Charged |
| LED Illuminated YELLOW | Error / No Battery Detected |

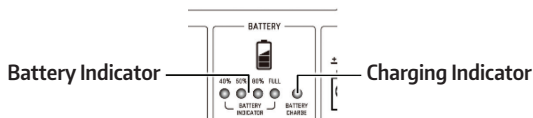

Module Compartment

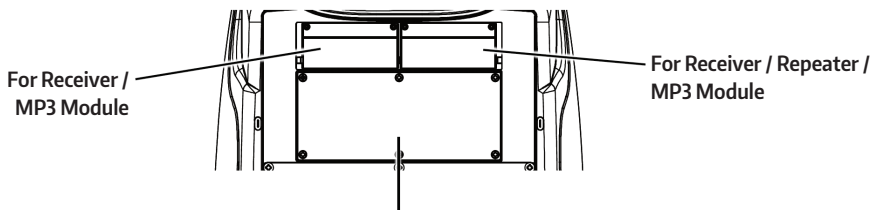

WIRED MIC / INSTRUMENT

AMPLIFIER

Sound control, eg. volume and equaliser, of audio output from HX-158x-II is controlled only by this external amplifier.

HELIX 158x **PARALLEL AUDIO**

INPUT 1 VOLUME INPUT 2 VOLUME EFFECT REVERB VOICE PRIORITY EQUALISER TREBLE MASTER VOLUME

MIC LINE MIC LINE OFF ON OFF ON BASS

LINE IN VOLUME LINE OUT

BLUETOOTH LOCK SWITCH EXTERNAL SPEAKER VOLUME BATTERY 40% 60% 80% FULL BATTERY INDICATOR BATTERY CHARGE OUT - DC - IN DC 12V DC 30V-30V POWER

PASSIVE SPEAKER

TABLET / PHONE

Using a Wired Microphone – INPUT 1 & INPUT 2

1. Plug a wired microphone with a 6.3mm or XLR connector to INPUT 1 or INPUT 2.

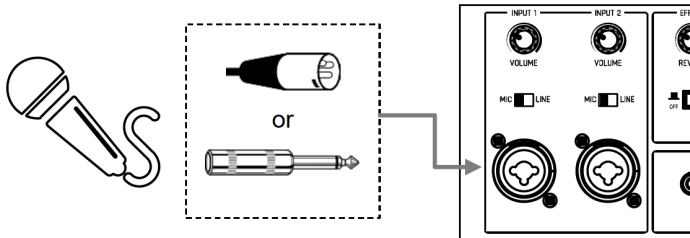

2. Slide MIC/LINE switch to MIC level.

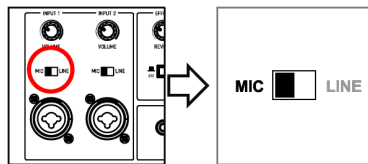

3. Turn on master POWER and then adjust INPUT 1 or INPUT 2 volume control to desired level.

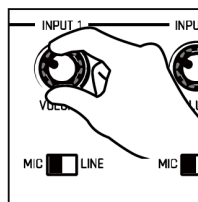

4. EQUALISER Treble/Bass (refer to Page 10) and REVERB (refer to Page 11) levels can be adjusted individually.

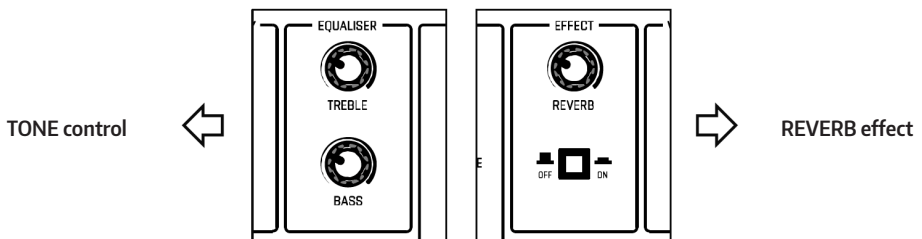

Using an Electronic Instrument – INPUT 1 & INPUT 2

1. Plug an electronic guitar or keyboard with a 6.3mm plug or XLR connector to INPUT 1 or INPUT 2.

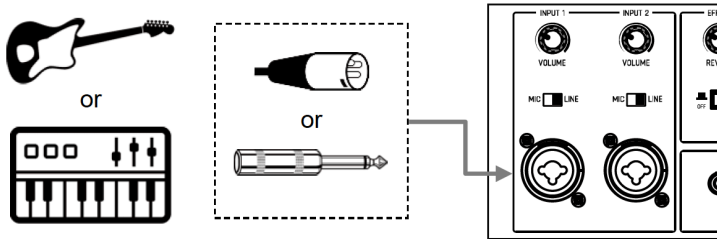

2. Slide MIC/LINE switch to MIC level.

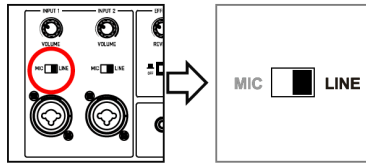

3. Turn on master POWER and then adjust LINE volume control to desired level.

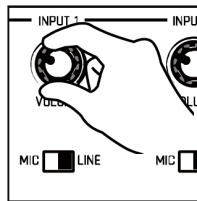

4. EQUALISER Treble/Bass (refer to Page 10) and REVERB (refer to Page 11) levels can be adjusted individually.

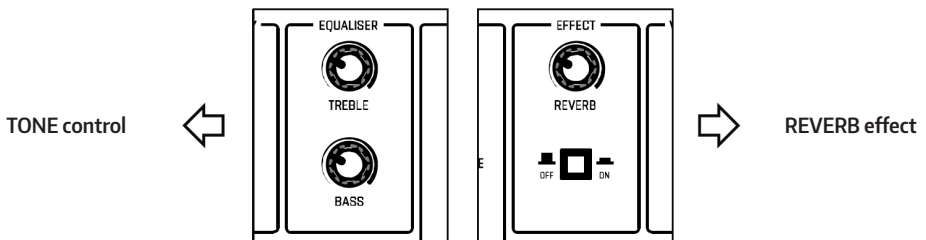

Music Audio Input – Smart Phone / Tablet / MP3 Player

1. Connect your device to the **LINE IN** 3.5mm jack using a 3.5mm 3-pole stereo audio cable.

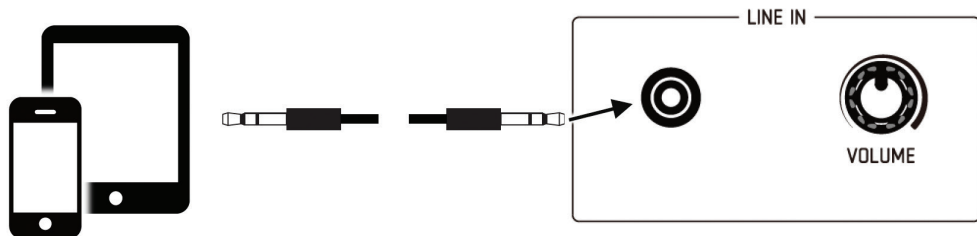

2. Turn on master **POWER** and then adjust **LINE IN** volume control to desired level.

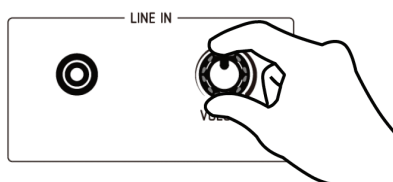

3. **EQUALISER** Treble/Bass levels can be adjusted individually (refer to Page 10).

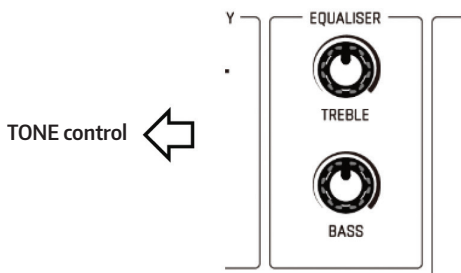

Operating BLUETOOTH Receiver

1. Turn on master **POWER** and then press the **SWITCH** button for 3 seconds to turn on the BLUETOOTH receiver. You will hear "POWER ON" and the pairing indicator LED will flash green.



Approximately 9 seconds later you will hear "READY TO PAIR" and the pairing indicator LED will flash green and red.

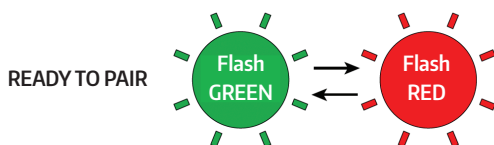

2. Activate BLUETOOTH on your device (phone, tablet, PC., etc) and pair with external device named "BT AUDIO". After successful pairing, you will hear "PAIR COMPLETED, DEVICE CONNECTED", and the pairing indicator LED will illuminate green. You can now play music through your HX-158x-II PA.



3. Adjust master volume control to a desired level.

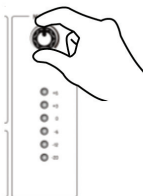

4. EQUALISER Treble/Bass levels can be adjusted individually (refer to Page 10).

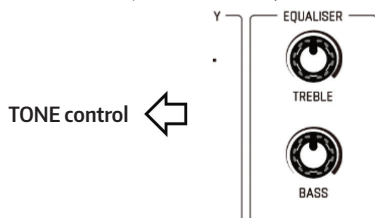

Important

- BLUETOOTH automatically turns off after 5 minutes if no music is playing.
- Press the **SWITCH** button for disconnection or to prepare for a new pairing.
- BLUETOOTH memorises and automatically connects to last-paired device.

EQUALISER for WIRED / WIRELESS MICROPHONE and MUSIC

EQUALISER adjustment is actually used to increase or reduce the high/medium/low frequency component of the speaker's restored sound. It is so-called raising or attenuating TREBLE/BASS via frequency-specific volume knobs to improve human voices or make musical instruments' sound more prominent. According to the scale marks on the panel, clockwise adjustment is to increase and boost and opposite direction to decrease and attenuate.

Adjust the level of high frequency (TREBLE) and low frequency (BASS) respectively. All signals have been balanced by the high and low sounds after entering the amplifier so it is not necessary to adjust the EQUALISER during the output to the speaker. It is recommended to maintain the position of BASS and TREBLE at 12 o'clock.

| KNOB | BASS | TREBLE |
|----------|--|---|
| FUNCTION | Reduce / Increase the low frequency component of the sound | Reduce / Increase the high frequency component of the sound |
| RANGE | -12dB ~ +12dB | |
| DEFAULT | 12 o'clock | |

Adjustment Reference:

BASS: It is the basic part of the sound. It accounts for 70% of the entire audio energy and is an important component to display the music style. When appropriate, the BASS is relaxed and the sound is full and soft. If you feel the sound is thin, you can moderately increase the BASS. If you feel the sound is muffled, not clear, or too nasal, you can moderately reduce the BASS.

TREBLE: It's the frequency that affects the sound layering. If you feel that the sounds of instruments such as Piccolo and Flute are too prominent, or the tooth sound of the voice is too heavy and the tone is sharp, you can moderately reduce the TREBLE.

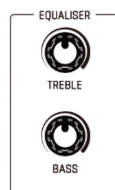

Operating Voice Priority

Voice Priority operation is only necessary when CD/USB/MP3 is playing.

When the Voice Priority switch is ON, the ducking function will be activated. While the music is playing, voice input from either a Wired or Wireless Microphone will temporarily override and lower the volume of the background music and speech will be heard more clearly.



Background music will return to its original volume when no audio is detected from the microphone for a few seconds.

Please Note: If the microphone is used within close proximity of the HX-158x-II speaker or other high level music playback the Voice Priority feature may be activated and lower the music level. It is recommended that if the microphone is not required whilst music is being played to switch off or mute the microphone.

Reverb

This function can add extra depth to the sound of WIRED or WIRELESS MICROPHONE to create a realistic acoustic ambience. You can adjust the reverb depth by using the REVERB knob. The depth range is from MIN through MAX. The MIN level produces no effect, while MAX level produces maximum reverb depth. When REVERB is turned off, no effect is applied.



Limiter Function

There's an interior anti-overload circuit to protect the amplifier from being damaged due to over volume output, this feature will automatically lower the output when it goes over the limit.

The purpose of the six input signal source (microphone, musical instrument or music) signal level indicators, from -20dB (min) to +6dB (max), is to display the real-time dynamic level of the sound signal. Please do not exceed the 5th indicator (+3dB) flashing when adjusting the volume of each input to prevent distortion.

| | | | | ! | ⊗ |
|--|---|--|---|--|---|
| <div style="display: flex; flex-direction: column; align-items: center;"> <div><input type="radio"/> +6</div> <div><input type="radio"/> +3</div> <div><input type="radio"/> 0</div> <div><input type="radio"/> -6</div> <div><input type="radio"/> -12</div> <div><input checked="" type="radio"/> -20</div> </div> | <div style="display: flex; flex-direction: column; align-items: center;"> <div><input type="radio"/> +6</div> <div><input type="radio"/> +3</div> <div><input type="radio"/> 0</div> <div><input type="radio"/> -6</div> <div><input checked="" type="radio"/> -12</div> <div><input checked="" type="radio"/> -20</div> </div> | <div style="display: flex; flex-direction: column; align-items: center;"> <div><input type="radio"/> +6</div> <div><input type="radio"/> +3</div> <div><input type="radio"/> 0</div> <div><input checked="" type="radio"/> -6</div> <div><input checked="" type="radio"/> -12</div> <div><input checked="" type="radio"/> -20</div> </div> | <div style="display: flex; flex-direction: column; align-items: center;"> <div><input type="radio"/> +6</div> <div><input type="radio"/> +3</div> <div><input checked="" type="radio"/> 0</div> <div><input checked="" type="radio"/> -6</div> <div><input checked="" type="radio"/> -12</div> <div><input checked="" type="radio"/> -20</div> </div> | <div style="display: flex; flex-direction: column; align-items: center;"> <div><input type="radio"/> +6</div> <div><input checked="" type="radio"/> +3</div> <div><input checked="" type="radio"/> 0</div> <div><input checked="" type="radio"/> -6</div> <div><input checked="" type="radio"/> -12</div> <div><input checked="" type="radio"/> -20</div> </div> | <div style="display: flex; flex-direction: column; align-items: center;"> <div><input checked="" type="radio"/> +6</div> <div><input checked="" type="radio"/> +3</div> <div><input checked="" type="radio"/> 0</div> <div><input checked="" type="radio"/> -6</div> <div><input checked="" type="radio"/> -12</div> <div><input checked="" type="radio"/> -20</div> </div> |

Using a Wireless Transmitter

Parts and Functions

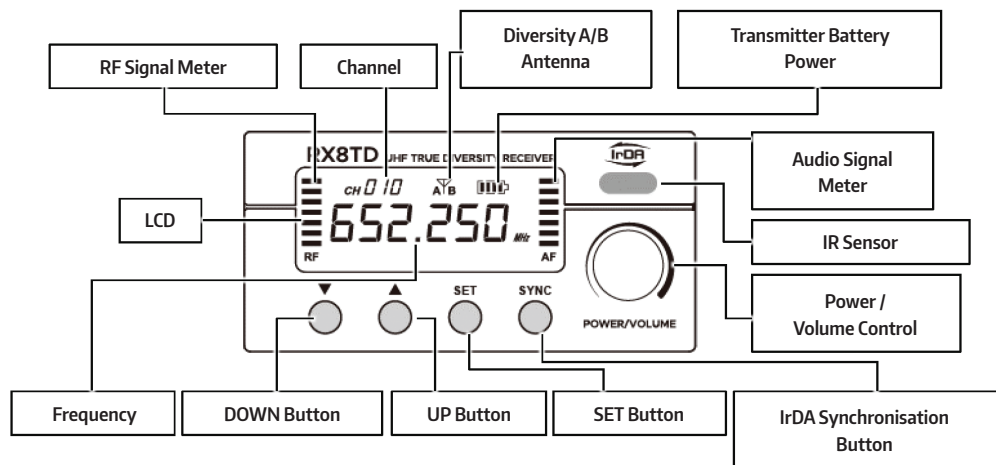

Channel Synchronising of the Receiver and Transmitter

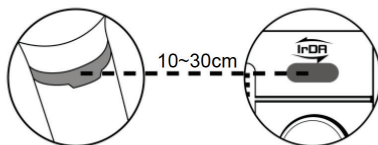

Align infrared areas of the receiver and transmitter within 10~30cm.

Sync Channel from Transmitter → Receiver

1. Press the **SYNC** button on the transmitter.
2. The transmitter's LED will illuminate to denote synchronisation signal transmitted.
3. The channel number on the receiver LCD will match the transmitter, which means the receiver has been successfully synchronised.

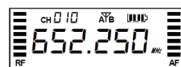
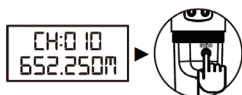

Sync Channel from Receiver → Transmitter

1. Press the **SYNC** button on the receiver.
2. The transmitter's LED will illuminate to denote synchronisation signal received.
3. The channel number on the transmitter LCD will match the receiver, which means the transmitter has been successfully synchronised.



Channel Scanning

For interference-free operation, a cleaner channel might be necessary if the current one receives too much interference. To operate scanning:

1. Press ▼ (down) or ▲ (up) button until the frequency icon [FREQ] appears at the bottom of the LCD.
2. Hold SET button until this icon [FREQ] flashes to denote readiness for setting.
3. Press ▼ (down) or ▲ (up) button to find and locate a clear, interference-free channel.
4. After a channel is chosen, press SET button or wait 5 seconds to store the setting.

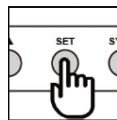
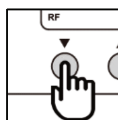
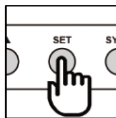
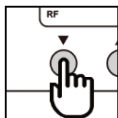

Adjusting Squelch (SQ) Level

When interference is encountered try reducing the sensitivity of the receiver, thus making it less susceptible to interference. To operate squelch setting:

1. Press ▼ (down) or ▲ (up) button to turn to the squelch setting page.
2. Hold SET button until this icon [SQ] flashes to denote readiness for setting.
3. Press ▼ (down) or ▲ (up) button to select a new squelch level between 01 and 10. The default level is 01.
4. After a level is chosen, press SET button or wait 5 seconds to store the setting.

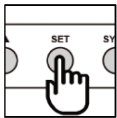
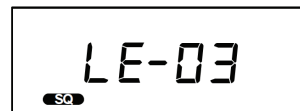
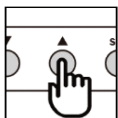
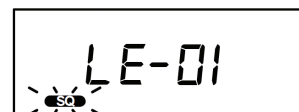
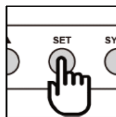
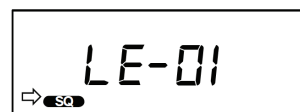
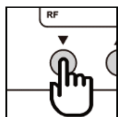

Since increasing the squelch level will also reduce the reception distance, it's recommended to choose the lowest level that can eliminate the interference.

If this still does not solve the problem it means this frequency is not suitable. Adjust the squelch back to its default level (LE-01) and use the scan function to locate a clear, interference-free channel.

Volume and Other Settings

- 1. Turn on master **POWER** and then adjust volume control to the desired level.

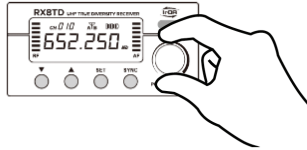

- 2. EQUALISER Treble/Bass (refer to Page 10) and REVERB (refer to Page 11) levels can be adjusted individually.

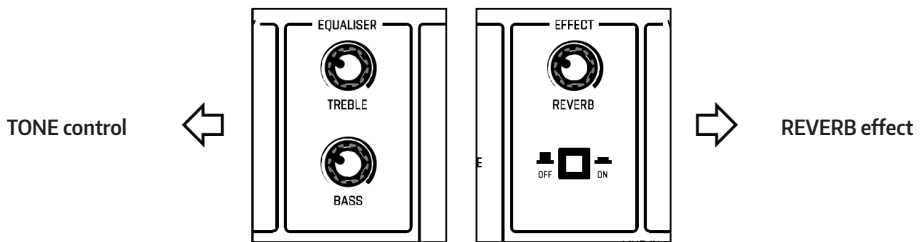

Wireless Audio Link – Repeat all audio to linked HX-158x-II and HX-8 PSR

HX-158x-II operates as the MASTER unit in a wireless audio link with other HX-158x-II or HX-8 PSR active companion powered speakers. The RP5 repeater module of master HX-158x-II can transmit all audio signals, including wired/wireless microphone, music, instrument, etc. to other units installed with receiver module.

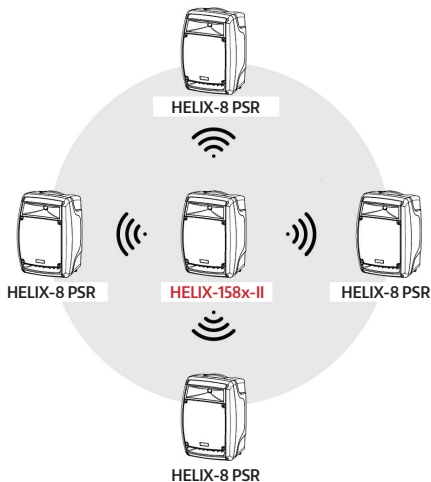

RP5 Module

Parts and Functions

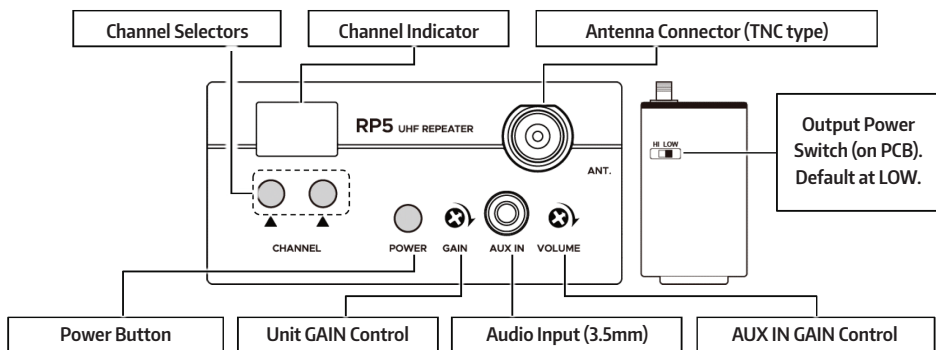

Changing Channels

Press LEFT ▲ button to increase the DOUBLE-digit channel number.

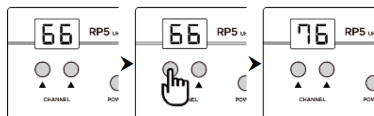

Press RIGHT ▲ button to increase the SINGLE-digit channel number.

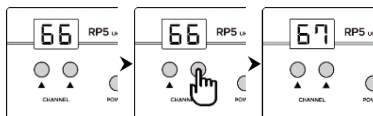

Music Audio Input – Smart Phone / Tablet / MP3 Player

1. Connect your device to the **AUX IN** 3.5mm jack using a 3.5mm 3-pole stereo audio cable.

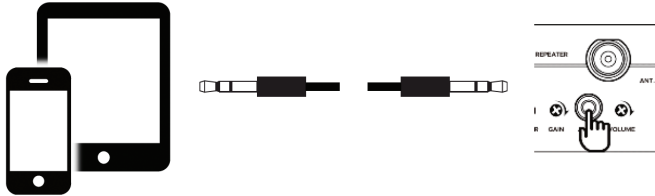

2. Use a mini screw driver to adjust the volume of the input audio.

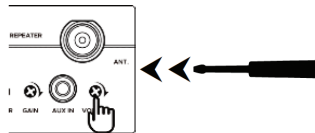

Adjusting the Internal Audio Gain Level

Use a mini screw driver to adjust the volume of audio sources in the master unit.

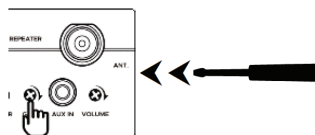

Output Power Setting

- **LOW** position (default) for low output power and **HI** for high output power.
- **LOW** output power will reduce the RF transmission distance and **HI** output power will extend the possible RF transmission distance.
- If the module is installed on battery-powered amplifiers, remember **HI** output power places slightly more load on the battery and will reduce operating duration faster than **LOW** output power.

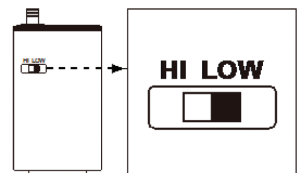

Transmitting from Master to Companion Units

1. Install an RP5 repeater module on the master HX-158x-II. Set the channel/frequency on the repeater module which will be used to transmit signals to other units. The channel/frequency must be different from other modules on all master and companion units.

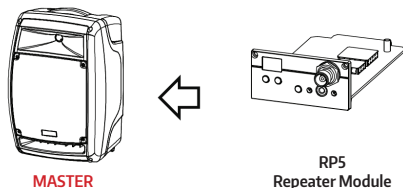

2. Install a RX8TD/RX8D receiver module on companion HX-158x-II or HX-8 PSR. Set the channel/frequency on the receiver module which will be used to receive signals from the master HX-158x-II. Both repeater and receiver module must be the same channel/frequency.

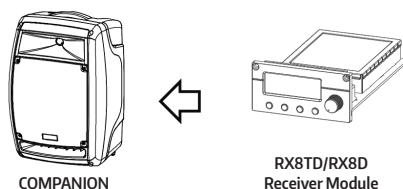

3. Turn on master **POWER** of HX-158x-II and each HX-8 PSR and then adjust master **VOLUME** control to a desired level. Turn on power of **EACH** HX-8 PSR and then adjust the volume control to a desired level.

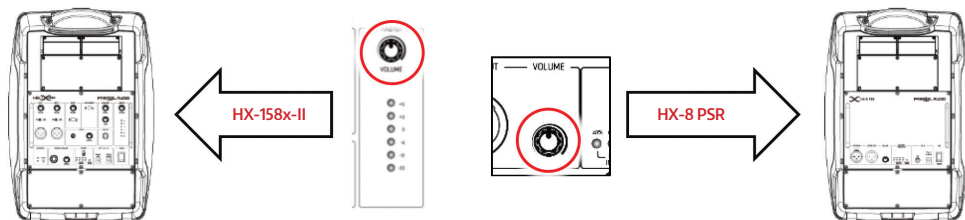

4. EQUALISER Treble / Bass levels can be adjusted individually (refer to Page 10).

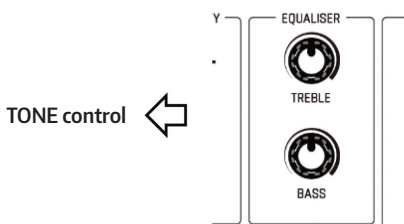

Extra Coverage

To reach wider coverage, the companion unit HX-158x-II or HX-8 PSR can serve as SUB-MASTER to transmit signals to SUB-COMPANION units.

Important: Please do not set the SUB-COMPANION as next MASTER in order to guarantee best sound quality.

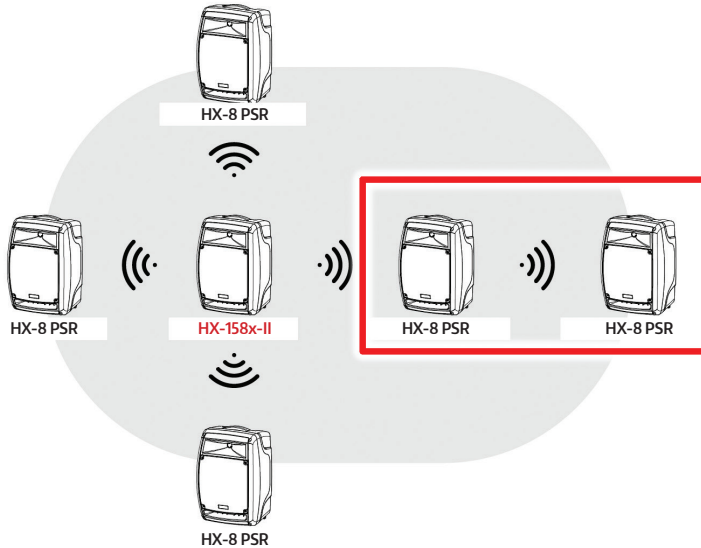

For this purpose, please install a repeater module on the SUB-MASTER unit and a receiver module on SUB-COMPANION units (same procedures as STEP 1 & 2). Both repeater and receiver module must be the same channel and same frequency which must be different from former repeater and receiver module.

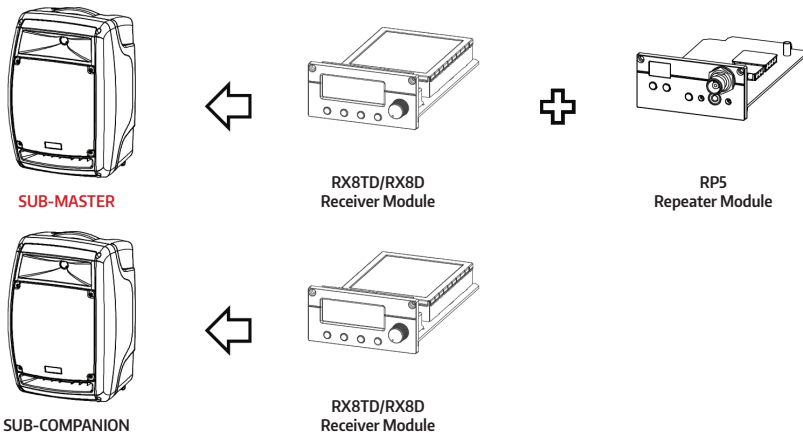

Connecting a Passive Companion Speaker

1. Plug the passive companion speaker's audio cable with a 6.3mm connector to the speaker input socket of HX-158x SP or another 4~8Ω load speaker. Max cable length less than 20m.

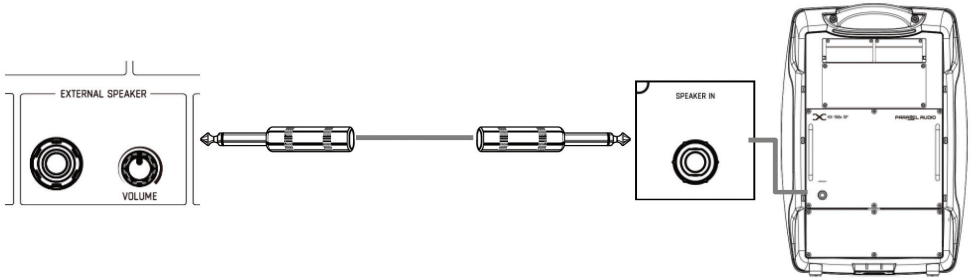

2. Turn on master **POWER** and then adjust its individual volume control to a desired level.

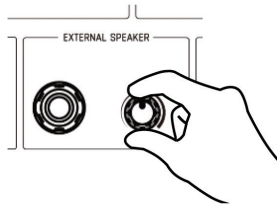

Installing or Replacing a Receiver/Repeater/MP3 Module

There are four slots above the control panel and two on HX-MB module bracket for installing optional modules which includes receiver, repeater and MP3 recorder modules.

1. Use a Phillips-head screwdriver (not included) to remove the screws of the blank cover panel or current module's panel.

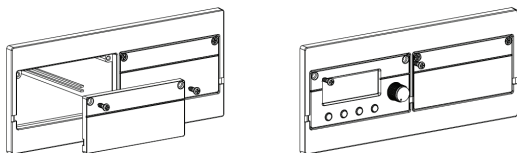

2. To replace module, use a mini flat-head screw driver (not included) to pry up the current module's panel and remove the module.

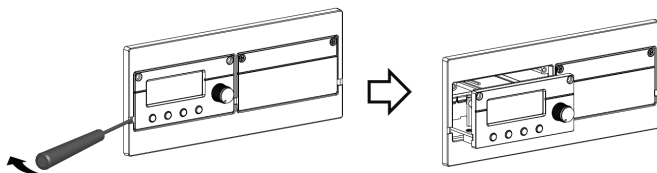

3. Gently insert the module into the slot by aligning its edges to the guide rails. Then push the panel to make sure it's been firmly connected.

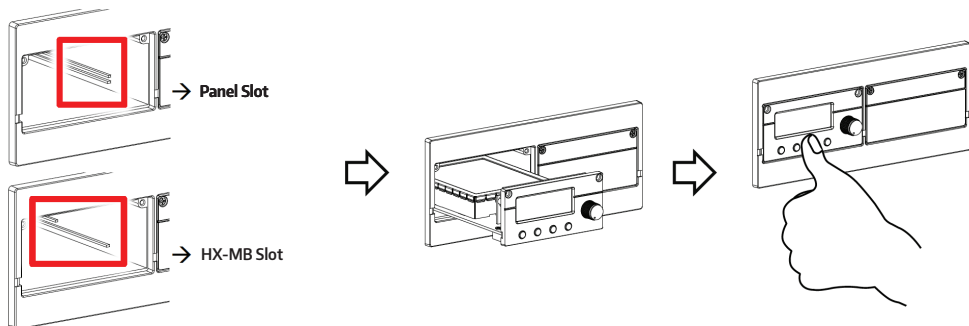

4. Tighten up the screws.

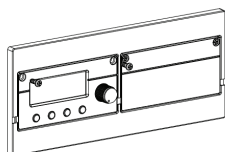

FAQ and Useful Operation Tips

1. How to adjust the best volume?

Gradually adjust the volume of audio inputs from minimum to an appropriate level. Then adjust volume according to the surrounding environment and the required sound (microphone, MP3 ... etc.).

2. Is it possible to play music storing on external devices via wireless amplifier?

Yes. Parallel Audio's wireless amplifiers have auxiliary audio input(s) LINE IN (or AUX IN) for connection with external devices such as notebook, mobile phones or tablets. (Medium and larger-sized wireless amplifiers can also be installed with MP3 recorder modules and equipped with remote control for more versatile functionality.)

3. Is it possible to record the sound of Microphone or external devices when using HX-158x-II?

Yes. Install an MP3 recorder player (DPR5) on HX-158x-II to obtain recording function.

4. How to avoid or reduce feedback?

(A) Do not stand in front of the speaker when using the microphone.



(B) Do not point the wireless microphone towards the speaker.

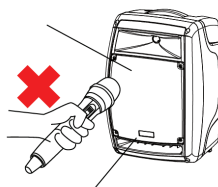

(C) Use the microphone behind the speaker if possible.



(D) Locate the wireless amplifier between the speaker and the audience with the speaker facing the crowd. Place the wireless amplifier on a tripod stand and above the head of audience (about 180cm).

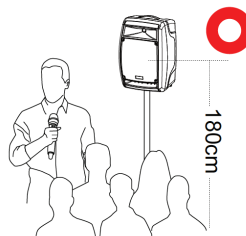

(E) Turn down the volume if necessary.

5. Does the wireless PA need to be installed with a tripod? What is the ideal height for the PA to be positioned above the ground?

Placing your wireless PA in a high position will help signal reception. It can be mounted on a tripod, above ear-level of the audience. If it is not possible to set up a tripod, you can place your PA on a table or other flat object, making sure the PA sits above ground level by 1 metre or more.

6. Will the PA automatically power off once it is fully charged? Do I need to unplug the power cord?

Yes, all Parallel Audio amplifiers have an overcharge protection circuit that automatically shuts off power at full charge to prevent damage to the system.

For safety purposes, please also unplug the power cord once fully charged.

7. How to charge and maintain the battery of wireless amplifier?

After plugging the power cable of the PA into a standard outlet, the charging LED will illuminate or flash, indicative of charging status. The PA will charge regardless of whether power is on or off.

The PA's battery has no memory effect and can be charged any time. It is suggested to charge the battery right after usage to extend battery life. If the PA is not used for long periods, please charge the battery at least every three months for lead-acid batteries and six months for lithium batteries.

The battery life is limited and affected by the environment, charging method and battery efficiency.

8. Is it possible to have the HX-158x-II work as an amplifier only? Can I use only one, or more microphones? What is the maximum number of wireless microphones that can be used?

The wireless receiver, transmitter and MP3 recorder player (DPR5) for HX-158x-II are modular products which can be installed optionally according to application and requirement.

Maximum 4 wireless microphones can be used simultaneously.

9. What is the difference between lead-acid batteries and lithium batteries?

Lithium battery: light weight, electronic circuit protection, long life and more expensive.

Lead-acid battery: heavy weight, short life and more affordable.

Maintenance-Free Lead-Acid and Lithium Batteries

Cautions when using the battery

1. Do not operate at temperatures lower than -10°C or higher than 50°C .
2. Do not let the battery make contact with any liquid. Do not immerse the battery in water or get it wet. After the battery is exposed to water, a decomposition reaction may occur, which may cause battery self-ignition or even cause an explosion.
3. Do not use the battery when it has swelled, leaked, or the packaging is damaged.
4. Do not disassemble the battery in any way or pierce the battery with a sharp object, so as not to cause the battery to catch fire or cause an explosion.
5. The liquid inside the battery is highly corrosive. If it leaks, do not touch it. If the internal liquid splashes on human skin or eyes, immediately rinse with clean water for at least 15 minutes before seeking medical attention.
6. Do not use wires or other metal objects to short-circuit the positive and negative electrodes of the battery.

Cautions when charging the battery

1. Lead-acid batteries/lithium batteries have no memory effect. Please charge them up immediately after each use, no matter how much power they have left. If the battery is not charged for a long time, it may cause the battery to be over-discharged and damaged, making it impossible to charge normally.
2. Please use the power supply specified by Parallel Audio for charging.
3. The Parallel Audio amplifier has a protection circuit to prevent overcharging. To ensure safety, the charging time should not exceed 12 hours. Please disconnect the power supply when fully charged.
4. Do not charge at temperatures lower than 0°C or higher than 40°C .
5. When charging, place PA on a flat, solid surface. There should be no flammable or combustible materials around. Pay attention to the charging process to prevent accidents.
6. PA battery will automatically stop charging when fully charged. After the battery is fully charged, it is recommended to disconnect the amplifier from the power supply.
7. When the power supply is still connected and the amplifier is not in use, if the battery is fully charged and then recharged again soon after, it will cause the battery to age and lose its ability to store power. Replacement of the battery will be necessary to ensure sufficient operation time.

Cautions when storing the battery

8. Lithium batteries will automatically discharge in storage. If they are not charged for a long time, they will over discharge, causing a decrease in capacity and damage to the batteries, which will no longer charge normally. Lithium batteries should be fully charged at least once every 6 months.
9. Lead-acid batteries will automatically discharge in storage. If they are not charged for a long time, they will over discharge, causing a decrease in capacity and damage to the batteries, which will no longer charge normally. Lead-acid batteries should be fully charged at least once every 3 months.
10. Do not store at temperatures lower than -10°C or higher than 40°C .

Disposing of the battery

Be sure to completely discharge the battery before placing it in the designated battery recycling bin. Batteries contain dangerous chemicals. When disposing of old batteries, be sure to follow local battery recycling and disposal regulations, do not dispose of them with your regular trash.

PARALLEL AUDIO WARRANTY INFORMATION – 5 Year Warranty Term

Consumer Guarantees

When you purchase a NAS distributed product, you have the peace of mind in knowing that your product is covered by the NAS warranty. The NAS warranty is provided by:

In Australia: National Audio Systems Pty Ltd, ABN 50 085 679 894 ['NAS'], 127 Merrindale Drive, Croydon, Victoria 3136.

In New Zealand: NAS Solutions Limited, NZBN 9429046800992 ['NAS'], 7F Douglas Alexander Parade, Rosedale, Auckland 0632.

The Australian Consumer Law protects consumers by giving them certain guaranteed rights when they buy goods and services. Rights guaranteed under the Australian Consumer Law include;

- The goods are of acceptable quality;
- The goods match their description or any sample or demonstration model;
- The goods are fit for any represented purpose or purpose which the consumer has made known;
- Repairs and spare parts are reasonably available (unless notice has been provided that repairs or spare parts would not be available); and
- The services are carried out with reasonable care and skill and are completed within a reasonable time

These rights are called 'Consumer Guarantees' and apply automatically whenever goods or services are supplied to a consumer. These Consumer Guarantees cannot be refused, changed or limited.

Consumer Guarantees have no set time limit and depending on the price and quality of goods a Consumer may be entitled to a remedy after any manufacturers' or NAS's extended warranty has expired.

The Specific Warranty Table Information outlines the warranty period, warranty type and any specific exclusions for your NAS product. NAS considers the warranty period specified in the Specific Warranty Table to be a reasonable warranty period having regard to the price, design, manufacture and expected use of the product.

General Warranty ('Warranty')

NAS products come with guarantees that cannot be excluded under the Australian Consumer Law. You are entitled to a replacement or refund for a major failure or if the goods fail to be of acceptable quality. You are also entitled to have the goods repaired or replaced if the goods fail to be of acceptable quality and failure does not amount to a major failure. What constitutes a major failure is set out in the Australian Consumer Law.

Subject to the terms and conditions set out below, and unless otherwise specified in the Specific Warranty Information for your NAS product, NAS agrees to repair or replace, at NAS's cost, the NAS product purchased by you in Australia or New Zealand from NAS or a NAS authorised reseller when the product does not perform substantially in accordance with the specifications during the warranty period specified in the Specific Warranty Table for your NAS product. NAS makes no other express warranties in respect of your NAS product. To make a claim under this Warranty, valid proof of purchase must be presented when the warranty claim is made, along with any other required information. The Warranty offered by NAS is not transferable.

The Warranty will only apply if your NAS product has been installed and used in accordance with NAS's recommendations as noted in the operating instructions.

Warranty Exclusions

The Warranty does not cover damage caused by;

- Misuse or abuse of the product by You;
- Incorrect operation or not following the operation instructions (as noted in the operating instructions);
- Improper installation;
- Incorrect or improper maintenance or failure to maintain the product;
- Failure to clean or improper cleaning of the product;
- Incorrect voltage or non-authorized electrical connections;
- Adverse external conditions such as incorrect or fluctuations in electrical voltage, thunderstorm activity, acts of God, acts of terrorism, damage caused by vermin, or any other circumstance beyond NAS's control;
- Exposure to excessive heat, moisture or dampness;
- Exposure to abnormally corrosive conditions;
- Alterations or modifications to the product made by You or a third party; or
- Damage as a result of accident, liquid, grit, impact or lack of proper care as indicated in the operating instructions;
- Damage resulting from the use of cleaning solvents such as acetone

The Warranty does not apply if any serial number or appliance plate on the product has been tampered with, removed or defaced.

The Warranty does not apply if the product has been repossessed under any financial agreement.

The Warranty excludes accessories and consumable goods which have ceased working through normal wear and tear such as, but not limited to, batteries, lamps and other parts classifiable as a consumable part.

The Warranty does not cover the loss of any data howsoever caused. You shall be responsible for backing up and protecting data against loss, damage or destruction.

Products presented for repair may be replaced by refurbished products of the same type rather than being repaired. Refurbished parts may be used to repair the products. Replacement of the product or a part does not extend or restart the Warranty Term.

The product will be at the owner's risk whilst in transit to and from all NAS authorised service centres, unless transported by NAS or its authorised representatives.

NAS and its authorised service centres may seek reimbursement of any costs incurred by them when the product is found to be in good working order.

The cost of claiming under this warranty, including return of any product to NAS is to be borne by the consumer.

The Warranty excludes removal or reinstallation costs.

*** All Parallel Audio products come with a 5 year warranty term, excluding Parallel Audio batteries and CD players (see below).**

Parallel Audio Limited Battery and CD Player Warranty: Batteries and CD players fitted to all Parallel Audio portable PA products carry a 3 months warranty.

For further information and warranty claims, refer to our **Support** page at www.nas.solutions.