

# M4000

## Quad-Channel UHF Receiver Base



OPERATION MANUAL V1.0

PARALLEL AUDIO®

Thank you for purchasing this professional modular wireless system.

This versatile modular cabinet can be used for four RECEIVER modules.

Before operation, please read this manual thoroughly to familiarise with the function of each part and the flexibility of this versatile cabinet.

## In the Box

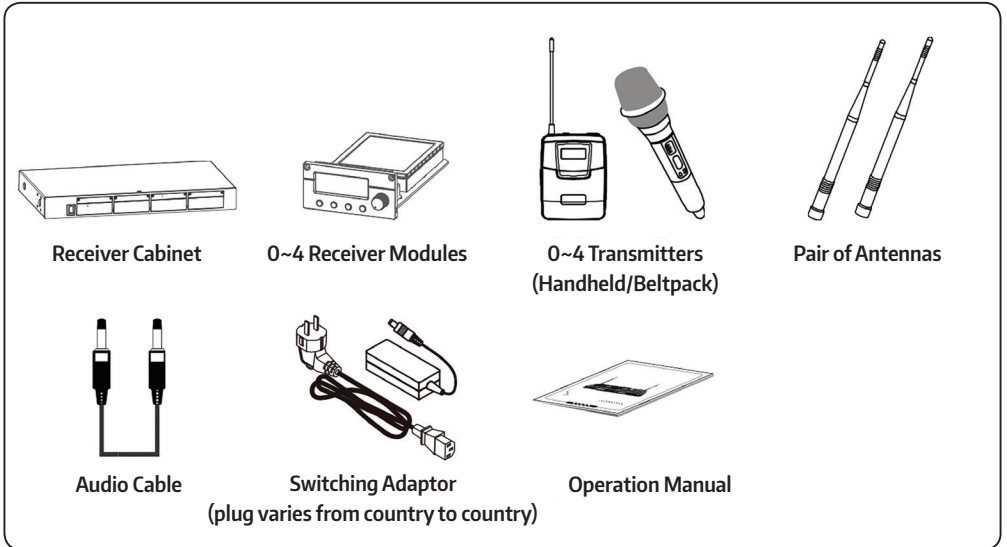

Note: The above specifications are subject to change without prior notice.

## Parts and Functions

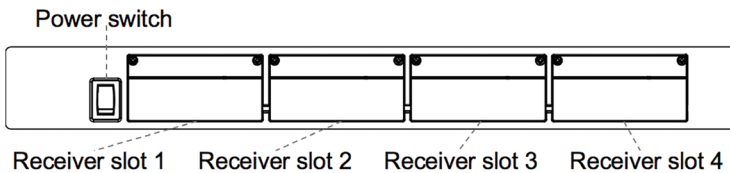

- CH 1 balanced audio output
- CH 2 balanced audio output
- CH 3 balanced audio output
- CH 4 balanced audio output

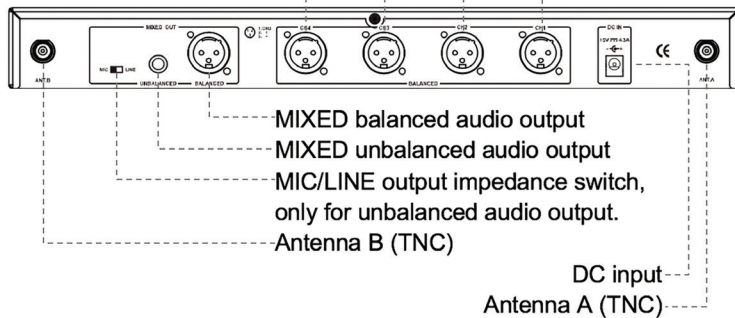

**Audio Output Connection**

There are two kinds of audio outputs on the back of the receiver:

- Balanced output of channels 1~4: Low-impedance MIC level.
- Unbalanced output of channels 1~4 (mixed): High-impedance LINE level / Low-impedance MIC level. Switchable between MIC and LINE levels.

Use shielded audio cable for the connection between the receiver and the amplifier/mixer. If the amplifier/mixer has a 1/4"(6.3mm) phone jack, connect a cable from the 1/4"(6.3mm) unbalanced audio output from the receiver to the amplifier/mixer. If the amplifier/mixer has an XLR input, connect a cable from the balanced XLR audio output from the receiver to the amplifier/mixer input.

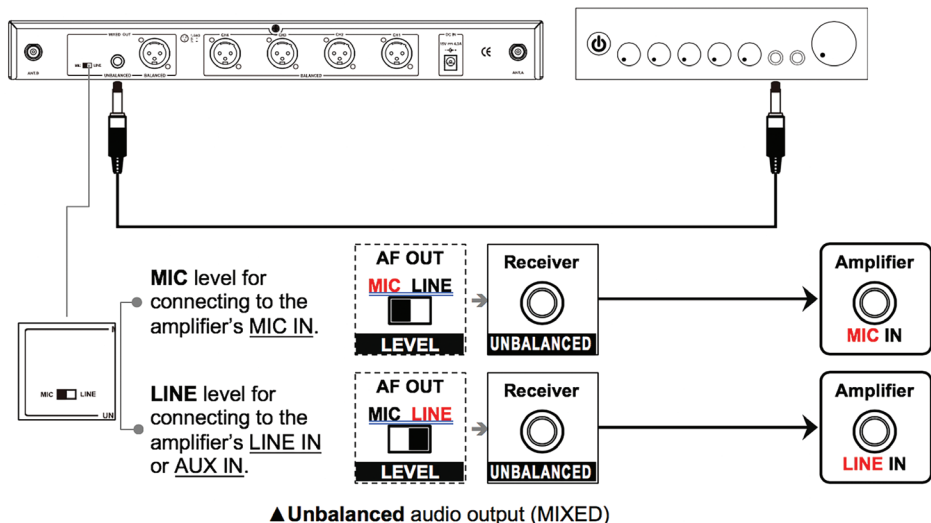

▼ **Balanced audio output**

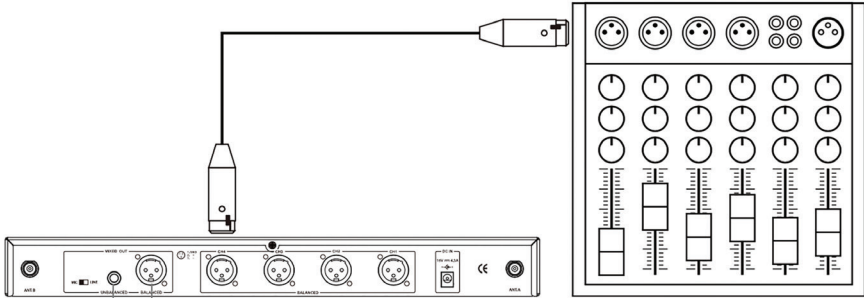

**Mixed audio output**

Connect to either XLR or 6.3mm jack of **MIXED OUT**. All channels' audio will be mixed to output.

**Rack Mounting**

M4000 is an EIA standard 1U rack-mountable receiver base with metal chassis. It can be cabinet-mounted with provided kits. Please refer to the following assembly illustration.

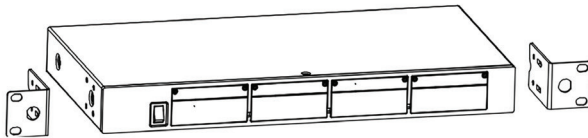

**Receiver Installation**

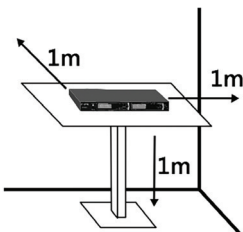

For best operation, the receiver should be at least 1m above the ground and 1m away from a wall or metal surface to minimise reflections. The transmitter should also be at least 1m away from a wall or metal surface to minimise reflections. The transmitter should also be at least 1m away from the receiver. Keep antennas away from noise source such as motors, automobiles, neon light as well as large metal objects.

## PARALLEL AUDIO WARRANTY INFORMATION – 5 Year Warranty Term

### Consumer Guarantees

When you purchase a NAS distributed product, you have the peace of mind in knowing that your product is covered by the NAS warranty. The NAS warranty is provided by:

**In Australia:** National Audio Systems Pty Ltd, ABN 50 085 679 894 [‘NAS’], 127 Merrindale Drive, Croydon, Victoria 3136.

**In New Zealand:** NAS Solutions Limited, NZBN 9429046800992 [‘NAS’], 7F Douglas Alexander Parade, Rosedale, Auckland 0632.

The Australian Consumer Law protects consumers by giving them certain guaranteed rights when they buy goods and services. Rights guaranteed under the Australian Consumer Law include:

- The goods are of acceptable quality;
- The goods match their description or any sample or demonstration model;
- The goods are fit for any represented purpose or purpose which the consumer has made known;
- Repairs and spare parts are reasonably available (unless notice has been provided that repairs or spare parts would not be available); and
- The services are carried out with reasonable care and skill and are completed within a reasonable time

These rights are called ‘Consumer Guarantees’ and apply automatically whenever goods or services are supplied to a consumer. These Consumer Guarantees cannot be refused, changed or limited.

Consumer Guarantees have no set time limit and depending on the price and quality of goods a Consumer may be entitled to a remedy after any manufacturers’ or NAS’s extended warranty has expired.

The Specific Warranty Table Information outlines the warranty period, warranty type and any specific exclusions for your NAS product. NAS considers the warranty period specified in the Specific Warranty Table to be a reasonable warranty period having regard to the price, design, manufacture and expected use of the product.

### General Warranty (‘Warranty’)

NAS products come with guarantees that cannot be excluded under the Australian Consumer Law. You are entitled to a replacement or refund for a major failure or if the goods fail to be of acceptable quality. You are also entitled to have the goods repaired or replaced if the goods fail to be of acceptable quality and failure does not amount to a major failure. What constitutes a major failure is set out in the Australian Consumer Law.

Subject to the terms and conditions set out below, and unless otherwise specified in the Specific Warranty Information for your NAS product, NAS agrees to repair or replace, at NAS’s cost, the NAS product purchased by you in Australia or New Zealand from NAS or a NAS authorised reseller when the product does not perform substantially in accordance with the specifications during the warranty period specified in the Specific Warranty Table for your NAS product. NAS makes no other express warranties in respect of your NAS product. To make a claim under this Warranty, valid proof of purchase must be presented when the warranty claim is made, along with any other required information. The Warranty offered by NAS is not transferable.

The Warranty will only apply if your NAS product has been installed and used in accordance with NAS’s recommendations as noted in the operating instructions.

### Warranty Exclusions

The Warranty does not cover damage caused by;

- Misuse or abuse of the product by You;
- Incorrect operation or not following the operation instructions (as noted in the operating instructions);
- Improper installation;
- Incorrect or improper maintenance or failure to maintain the product;
- Failure to clean or improper cleaning of the product;
- Incorrect voltage or non-authorised electrical connections;
- Adverse external conditions such as incorrect or fluctuations in electrical voltage, thunderstorm activity, acts of God, acts of terrorism, damage caused by vermin, or any other circumstance beyond NAS’s control;
- Exposure to excessive heat, moisture or dampness;
- Exposure to abnormally corrosive conditions;
- Alterations or modifications to the product made by You or a third party; or
- Damage as a result of accident, liquid, grit, impact or lack of proper care as indicated in the operating instructions;
- Damage resulting from the use of cleaning solvents such as acetone

The Warranty does not apply if any serial number or appliance plate on the product has been tampered with, removed or defaced.

The Warranty does not apply if the product has been repossessed under any financial agreement.

The Warranty excludes accessories and consumable goods which have ceased working through normal wear and tear such as, but not limited to, batteries, lamps and other parts classifiable as a consumable part.

The Warranty does not cover the loss of any data howsoever caused. You shall be responsible for backing up and protecting data against loss, damage or destruction.

Products presented for repair may be replaced by refurbished products of the same type rather than being repaired. Refurbished parts may be used to repair the products. Replacement of the product or a part does not extend or restart the Warranty Term.

The product will be at the owner’s risk whilst in transit to and from all NAS authorised service centres, unless transported by NAS or its authorised representatives.

NAS and its authorised service centres may seek reimbursement of any costs incurred by them when the product is found to be in good working order.

The cost of claiming under this warranty, including return of any product to NAS is to be borne by the consumer.

The Warranty excludes removal or reinstallation costs.

**\* All Parallel Audio products come with a 5 year warranty term, excluding Parallel Audio batteries and CD players (see below).**

**Parallel Audio Limited Battery and CD Player Warranty:** Batteries and CD players fitted to all Parallel Audio portable PA products carry a 3 months warranty.

For further information and warranty claims, refer to our **Support** page at [www.nas.solutions](http://www.nas.solutions).